

JBoss Platform

Open Source Software Superior Business Model

Wiesław Pilarczyk

wp@vdel.com

4.09.2008, Riga



redhat
MASTER
DISTRIBUTOR



Agenda

- Business requirements and software architectures
- Implementation using JBoss platform
- Open source software – superior business model
- Roadmap
- Red Hat offer
- References
- Q&A



redhat
MASTER
DISTRIBUTOR



Implementation using JBoss

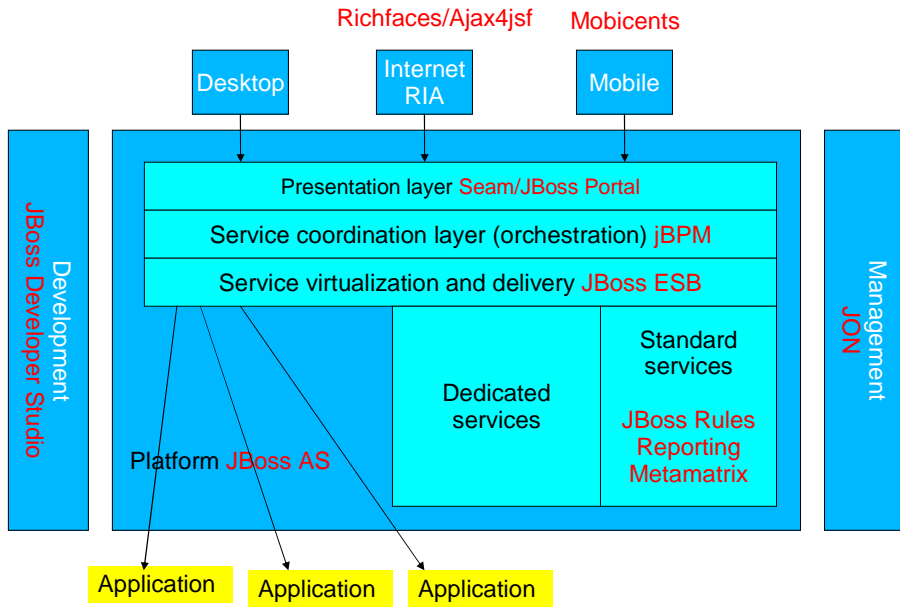

JBoss Application Server

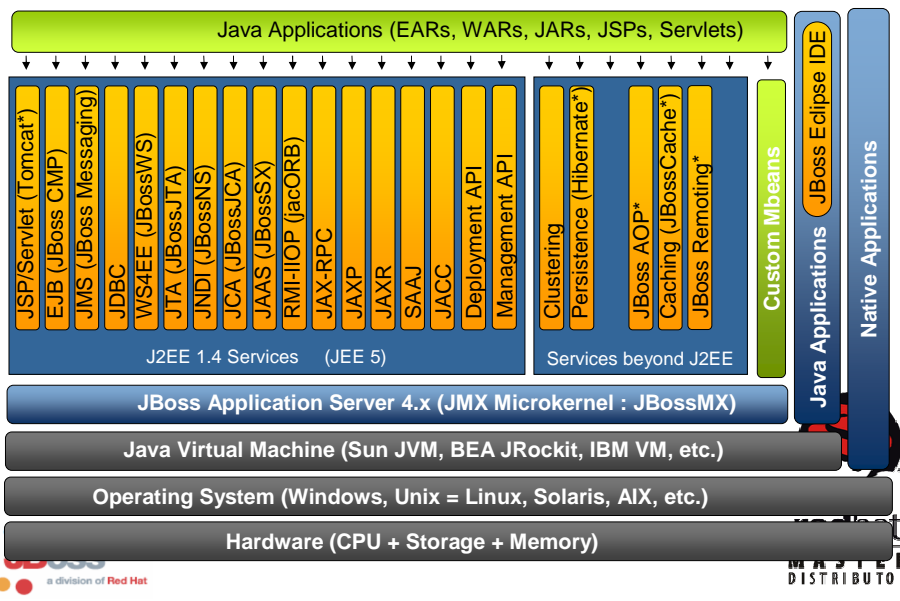

Seam

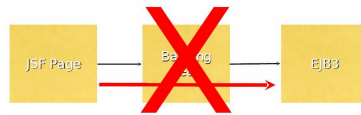

Stateless Context
 Session Context
 Application Context
 Event Context
 Page Context
 Conversation Context
 Business Process Context

Seam components
 JPA
 Bijection
 Ajax support
 Pageflow
 Workflow
 Rules
 Security
 Application framework
 more ...



redhat
 MASTER
 DISTRIBUTOR



Hibernate - ORM

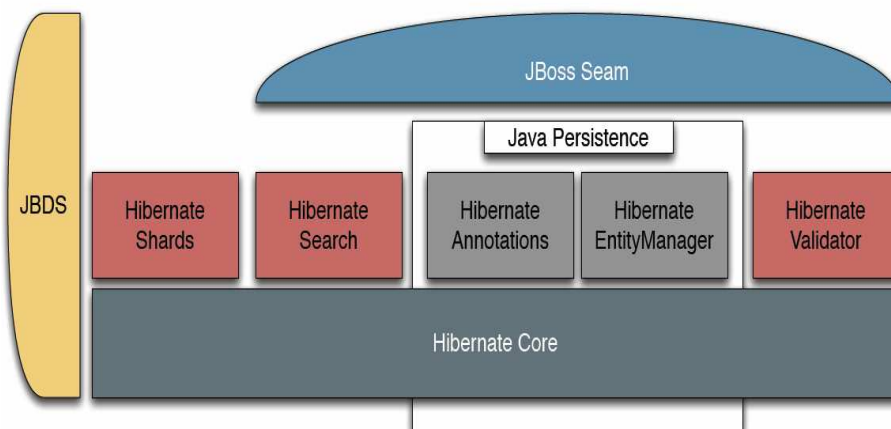

redhat
 MASTER
 DISTRIBUTOR



AS5 - JBoss Web Services 2.0.3.GA (JBossWS - Native)

- Java EE certified JAX-WS support
- J2EE certified JAX-RPC support (in maintenance)
- Attachment support with XOP & SwA
- JMS Transport
- WS-Addressing
- WS-Security
- WS-Policy
- WS-Eventing
- WS-Reliable Messaging
- Record Management



AS 5 - JBoss Messaging v1.4.1 Highlights

- High Performance JMS 1.1 compliant provider (Java5)
- XA implementation/integration with JBoss Transactions
- Clustered Queues and Topics (out-of-the-box)
- Intelligent message redistributions
- Transparent failover
- In memory message replication
- Support for very large messages & paging
- JDBC Persistence
Oracle, MySQL InnoDB, PostgreSQL, Sybase, SQLServer



JBoss Web

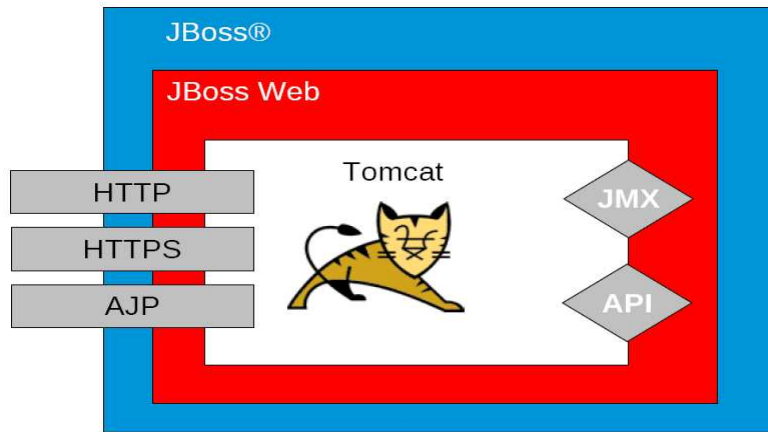

JBoss Remoting

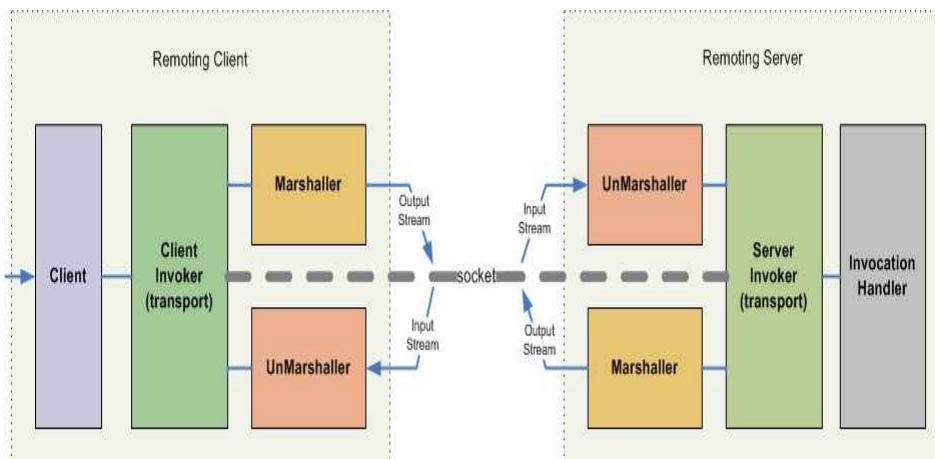

JBoss AOP, Javassist

```
public class BankAccount {
    public void withdraw(double amount) {
        // Actual method body...
    }
}

public class Metrics {
    public Object profile(MethodInvocation invocation) {
        long startTime = System.currentTimeMillis();
        invocation.invokeNext();
        long endTime = System.currentTimeMillis() - startTime;
    }
}
...
<aop>
    <aspect class="Metrics"/>
    <bind pointcut="execution(public void BankAccount->withdraw(double amount))">
        <advice name="profile" aspect="Metrics"/>
    </bind>
</aop>
```



JBoss Cache

- JBoss Application Server - Clustering HTTP and EJB sessions, JPA entities
- Hibernate - entity caching
- SEAM - caching JSF generated content
- JBoss Portal
- Lucene/Hibernate Search - cluster-wide indexes
- GridGain - data grid component to complement compute grid
- Coming soon:
 - Drools - clustering rules engines
 - JBoss DNA - clustering metadata repositories



JGroups

Library for reliable multicasting

Provides

- Fragmentation
- Message retransmission
- Flow control
- Ordering
- Group membership, membership change notification

LAN or WAN based

- IP multicasting transport default for LAN
- TCP transport default for WAN



redhat
MASTER
DISTRIBUTOR

JBoss AS Clustering

- Dynamic Cluster Composition
 - Simple Cluster-wide Deployment
 - Fault Tolerance
 - Silent Failover
 - Fine-Grained State Replication
 - JBossCache, HTTP Session, SFSB, JNDI
 - Buddy Replication, Buddy Pools
 - Data Gravitation



redhat
MASTER
DISTRIBUTOR

jBPM and SOA

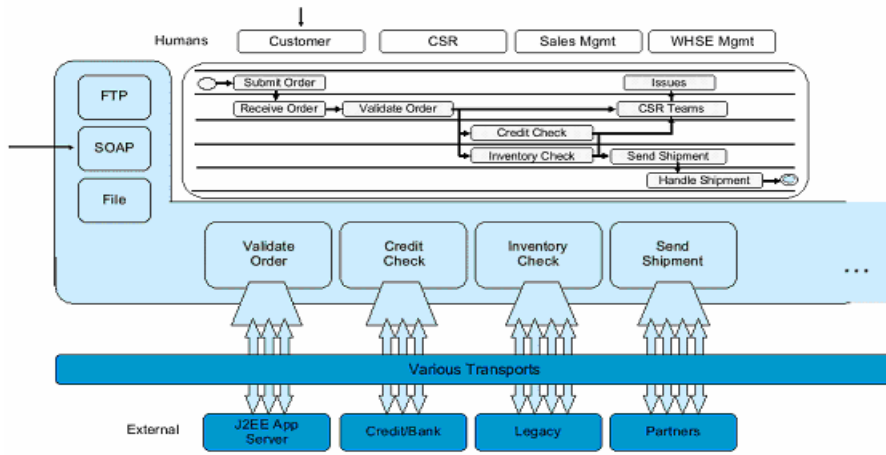

Process Editor

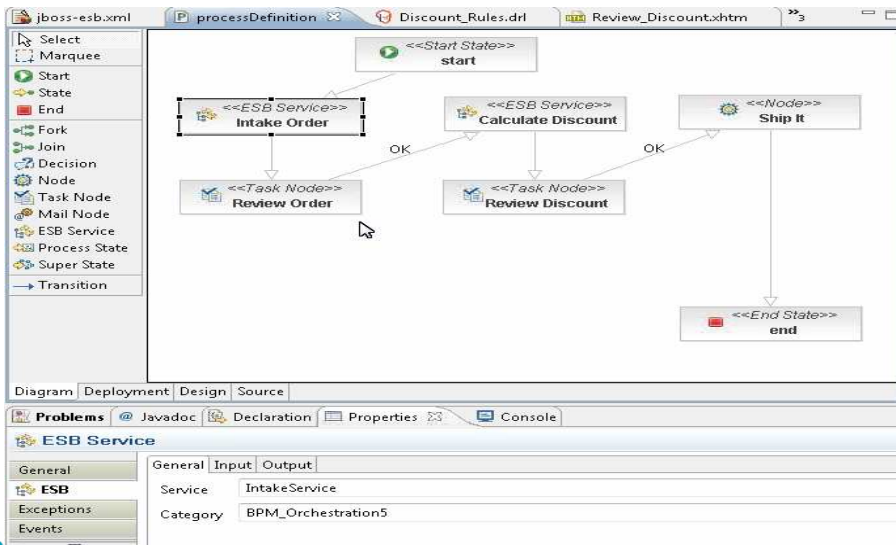

JBoss ESB

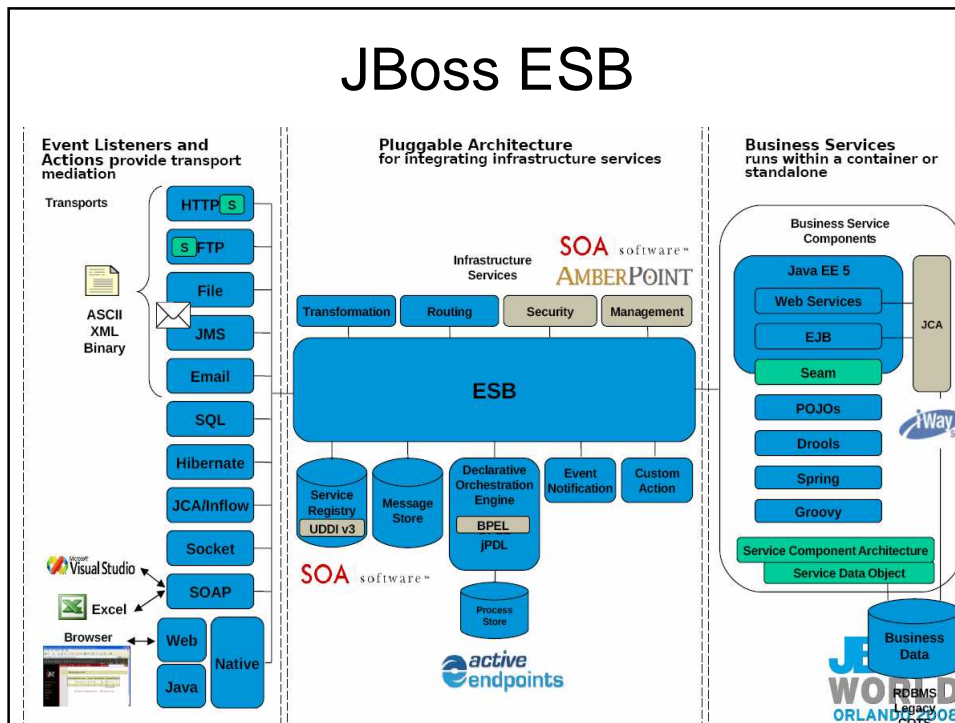

JBoss Rules – Rule Editor

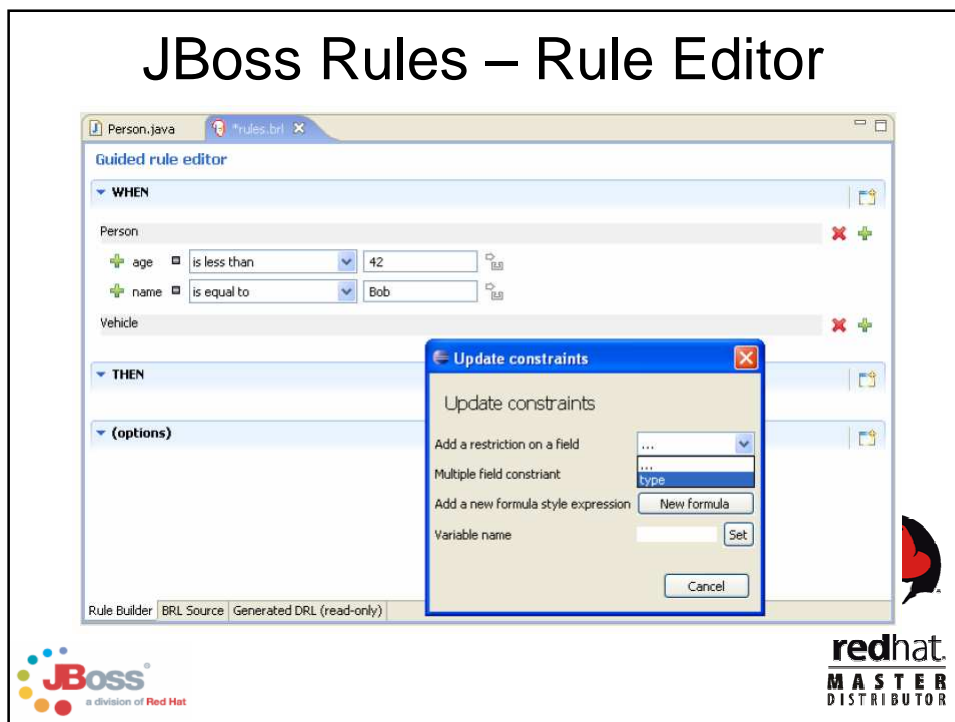

JBoss Rules – DSL

Language Expression	Rule Language Mapping	Object	Scope
There is a customer ticket with status of "{status}"	customer : Customer() ticket : Tick...		[condition]
There is a "{subscription}" customer with a ticket status of "{status}"	customer : Customer(subscription =...		[condition]
Log "{message}"	System.out.println("{message}");		[consequen...
Escalate the ticket	ticket.setStatus("Escalate"); update...		[consequen...
Send escalation email	sendEscalationEmail(customer, ticke...		[consequen...

Decision Tables (Excel/OpenOffice)

	B	C	D	E	F	G	H
9	Base pricing rules	Age Bracket	Location risk profile	Number of prior claims	Policy type applying for	Base \$ AUD	Record Reason
10	Young safe package	18-24	LOW	1	COMPREHENSIVE	450	
11			MED		FIRE_THEFT	200	Drivers not relevant
12			MED	0	COMPREHENSIVE	300	
13			LOW		FIRE_THEFT	150	
14			LOW	0	COMPREHENSIVE	150	Safe driver discount
15	Young risk	18-24	MED	1	COMPREHENSIVE	700	
16		18-24	HIGH	0	COMPREHENSIVE	700	Location risk
17		18-24	HIGH		FIRE_THEFT	550	Location risk
18	Mature drivers	25-30		0	COMPREHENSIVE	120	Cheapest possible
19		25-30		1	COMPREHENSIVE	300	
20		25-30		2	COMPREHENSIVE	590	
21		25-30		3	THIRD PARTY	800	High risk

Portal JBoss – Application Aggregation

The screenshot displays the JBossPortal application interface. At the top, there is a navigation bar with links for Home, News, Weather, Integration, and Struts. The main content area is divided into several sections:

- User portlet:** A login section with fields for Welcome, Register, and a message stating "You are currently not logged in."
- MyFaces JSF Portlet:** A section with a "Greetings!" message and three numbered icons (1, 2, 3).
- JSP Portlet:** A section with a "Welcome to JBoss Portal 2.0.3-GA" message and instructions for users.
- WSRP Content:** A section with a "Welcome to WebLogic Portal WSRP Demo" message and a link to the demo page.
- Sun RI JSF Portlet:** A section with a "HelloWorld JSF Portlet" message and input fields for First Name and Last Name.
- PHP Portlet:** A section with a "PHP Portlet" message and a "View Portlets" button.
- CMS Content:** A section titled "Programme TV" for "Mardi 22 janvier 2008" with a list of TV programs including "La Casseidienne", "Rex", "Des chiffres et des lettres", "L'île des îmmes perdus", and "Miroirs".
- Netvibes Widget:** A section with a "Bar 1 Simpson Pleasas" header and a cartoon image of Bart Simpson with a speech bubble that says "Hey, it's a teddy bear...Ew! Gross! It's probably diseased or something...Here Maggie." Below the image is a "View More Bart Simpson Pranks" link.
- Google Widget:** A section with a "Struts MailReader Demo" header and a "MailReader Demonstration Application (Struts 1.2.4)" message.

JBoss Developer Studio

Plugins over and above Eclipse

- Visual JSF Editor
- Hibernate
- JPA
- Struts
- Visual RichFaces support
- FreeMarker IDE
- JBoss AS incremental and hot deployment
- Seam support
- jBPM process designer
- ESB editor
- SpringIDE
- TestNG support



redhat.
MASTER
DISTRIBUTOR

JBoss Operations Network JON



Product Composition

JBoss.org Community

JBoss Enterprise Middleware

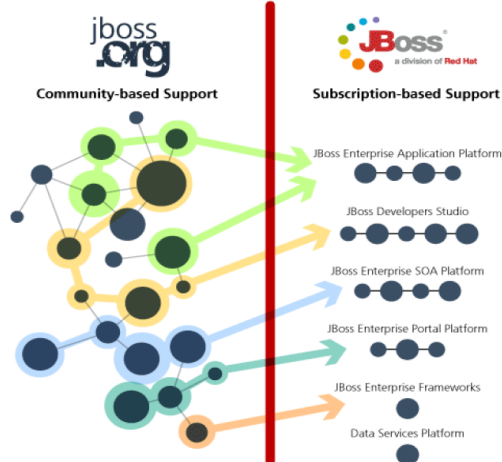

JBoss Enterprise Products

Design & Develop

Integrated Runtime Platforms

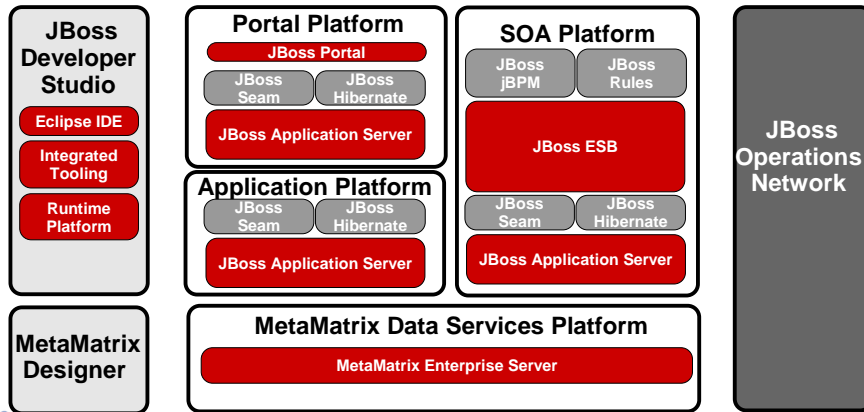

Red Hat Application Stack

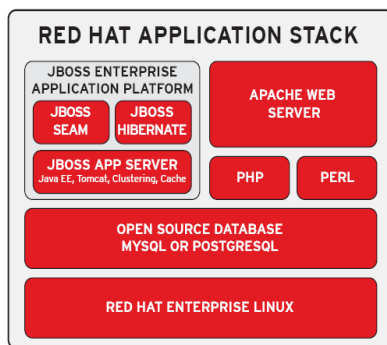

Single, integrated open source infrastructure stack with a single source for support

- Red Hat Enterprise Linux
 - GFS
 - Virtualization
- Apache HTTP Server
 - High Performance HTTP/S
 - Perl, PHP
- [JBoss Application Platform](#)
 - J2EE and beyond
- Database
 - MySQL
 - PostgreSQL



Added Value

Detailed Comparison

	JBoss.org	JBoss Enterprise
Open Source	X	X
Benefits from Worldwide Community Testing	X	X
Feature Releases	Experimental	Mature
Monthly Update Program		X
Quarterly Service Pack Program		X
Hot Fix Program		X
Automated Software Update and Alert Service		X
Bug Escalation Process		X
24x7 Production Support & Consultative Service		X
Platform & Training Certifications		X
Defined Support SLA & End-Of-Life Policy		X
Out-of-the-box Configured for Production Use		X
Includes JBoss Operations Network (JON)		X
Availability of JON Monitoring		X
Extensive Coordinated Internal/External Testing		X
Open Source Assurance & Indemnification Program		X



Subscriptions SLA

JBoss Technical Support	Developer Professional	Developer Enterprise	Production Standard	Production Premium
Hours	M-F 9-9 (North America) M-F 9-5 (Rest of World)	24x7	M-F 9-9 (North America) M-F 9-5 (Rest of World)	24x7
SLA	2 Business Days	4 Business Hours	4 Business Hours	1 Hour
Type of Access	Web & Phone	Web & Phone	Web & Phone	Web & Phone

- JBoss Professional Support Engineers are *Java EE experts*
- JBoss Core Development Team provide support services on a regular basis
- Developer Subscriptions cover all JBoss Enterprise Middleware, RHEL, and other Red Hat products.

